

The First World Vocational College
Skills Competition
Mechatronics Project

Test Project

Module I

Notice for competitors:

1. The Task Project consists of 26 pages, attached with one page of the troubleshooting table. If there is any problem with missing pages or illegible handwriting in the TP, please promptly indicate them to the judges and have them replaced.
2. There are two programming computers for the competition task, and the reference materials (including the components related to the competition platform, such as mechanical diagrams, electrical diagrams and manuals) are placed in the “D:\References” folder.
3. Teams should complete the content specified in the TP within **three hours**; the program files created by competitors during the Competition must be stored in the “D:\Skill Competition\Competition Number” folder. No points will be given to the operation records or program files that are not stored in the designated folder.
4. Competitors should not write their names or information related to their capacities on the submitted competition paper, or their results will be invalid.
5. Damage to PLC, touch screen, frequency converter, industrial robot controller and I/O components, and servo amplifiers due to incorrect wiring and improper operation will be handled in accordance with the competition rules.
6. In the process of completing the task, please save the program and data in time.

The First World Vocational College Skills Competition

I. Project Name: Mechatronics Project

II. Task Scenario: Assemble, program, and debug a small automated production line

There is a small automatic production line, which needs to be assembled, programmed and debugged according to customer requirements. Specifically, it includes designing, installing, debugging mechanical components and electrical systems, and being able to complete equipment control system and human-machine interface programming, as well as conducting maintenance, repair, system integration and technical improvement of automated production lines.

III. Project Tasks and Timeline: The mechatronics project mainly aims to assess competitors' performance on assembling, programming, and debugging a small automated production line which consists of five units: Particle feeding unit, capping and screw capping unit, detection and sorting unit, industrial robot handling unit, and intelligent storage unit. The Competition lasts for two days, in which, competitors should complete six tasks, and realize the automation of the production process. The cumulative completion time is six hours, and it should be completed by two students and one teacher in a team.

The tasks, content and time allocation of the Mechatronics Project of the World Vocational College Skills Competition are as follows:

Day	Module	Module content	Completion time	Task type
Day 1	Task A	Mechanical installation and debugging of units	3 hours	Mechanical assembly and debugging
	Task B	Electrical wiring and debugging of units		Electrical wiring
	Task C	Troubleshooting of units		Equipment maintenance
Day 2	Task D	Programming and debugging of units	3 hours	Programming and debugging
	Task E	Programming, debugging and optimization of mechatronics equipment system		Program optimization
Day 1-2	Task F	Professional quality	Whole Process	

Competition equipment description

The competition platform is mainly composed of particle feeding unit, capping and screw capping unit, detection and sorting unit, industrial robot handling unit, and intelligent storage unit. It can realize the whole automatic production process, including empty bottle feeding, particle material feeding, material sorting, particle filling, capping, screw capping, material detecting, bottle cap detecting, finished product sorting, robots handling qualified products into boxes, box cover packaging, labeling and warehousing.

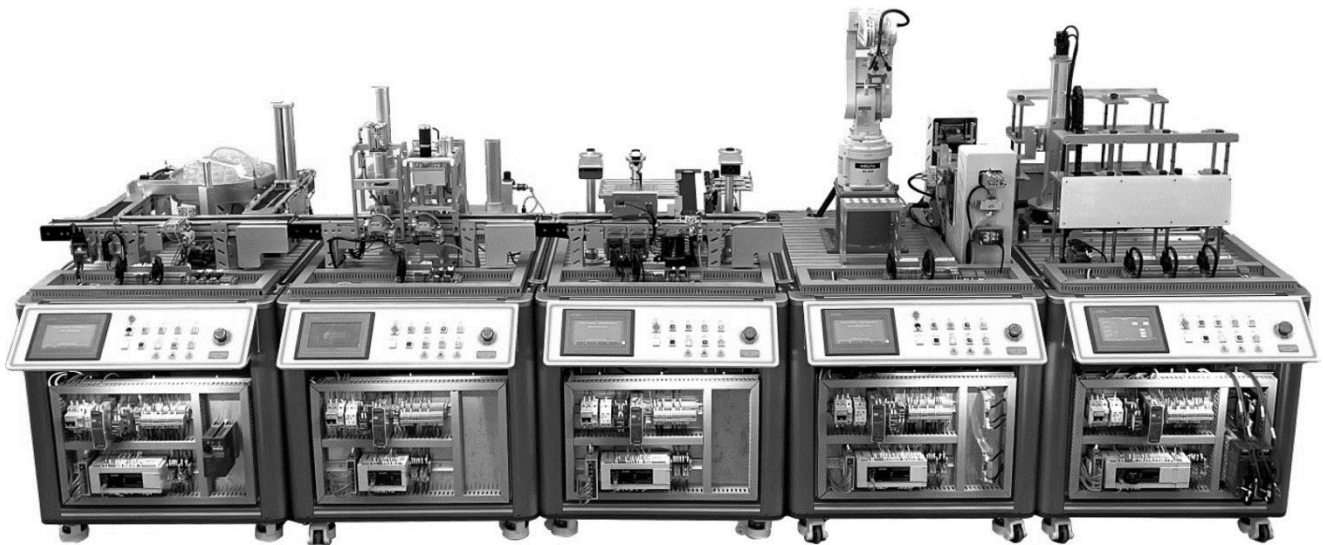

Figure 0-1 Schematic Diagram of Automated Production Line

The working process of this system is outlined as follows:

i. The disc conveying mechanism of the particle feeding unit conveys the empty bottles to the feeding conveying line. The disc empty bottle limit detection sensor detects the bottles, and the disc conveying mechanism stops. The feeding conveyor belt conveys the empty bottles to the main conveyor belt. When the empty bottles reach the filling position, the filling and positioning mechanism fixes the empty bottles and the main conveyor belt stops; at the same time, the feeding mechanism pushes out the corresponding color materials according to the task requirements; the filling mechanism sucks the particle material in place and puts it into the empty material bottles; after the filling material in the material bottle reaches the set quantity of particles, the filling and positioning cylinder is released; the main conveyor belt starts, and the material bottle is conveyed to the next workstation. It is shown in Figure 0-2.

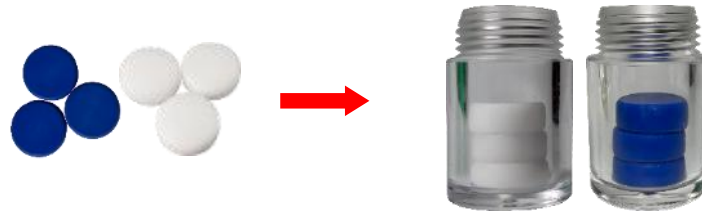

Figure 0-2 Material Bottling

ii. The material bottles are conveyed to the capping mechanism of the capping and screw capping unit, the capping and positioning mechanism fixes the material bottle, and the capping mechanism starts the capping process to add the cap (white or blue) the material bottle; the material bottle with the cap continues to be conveyed to the screw capping mechanism; below the screw capping mechanism, the screw capping and positioning mechanism fixes the material bottle, and the screw capping mechanism is activated to tighten the bottle cap.

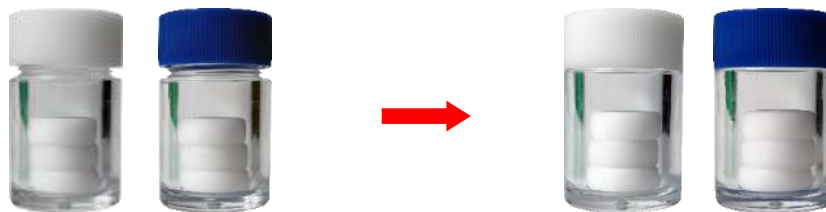

Figure 0-3 Capping and Screw Capping

iii. The bottles whose caps are screwed come to this unit for detection: The feeding detection sensor detects whether the material bottles whose caps are screwed are in place, and the retro-reflection sensor detects whether the bottle caps are tightened; the detection mechanism detects whether the particles inside the bottles meet the requirements; the cap color is judged and distinguished for the bottles with qualified screw capping and particles; the bottles with unqualified screw capping and particles will be pushed by the sorting mechanism to the waste belt for sorting; the bottles with qualified screw capping and particles will be conveyed to the end of the belt, waiting for the robots to handle them.



Figure 0-4 Schematic Diagram of Qualified and Unqualified Products

iv. Industrial robot handling unit: Two lifting platforms A and B store packaging boxes and box covers; Lifting Platform A pushes the packaging boxes to the material table; six-axis robots grab the bottles and puts them into the packaging boxes on the material table; after packing the full bottles of four workstations, the six-axis robots pick up the box covers from Lifting Platform B and cover them on the boxes; the six-axis robots label the boxes at the label position on the box cover according to the color of the bottle caps and wait for the finished product to enter the storehouse after sticking four labels.

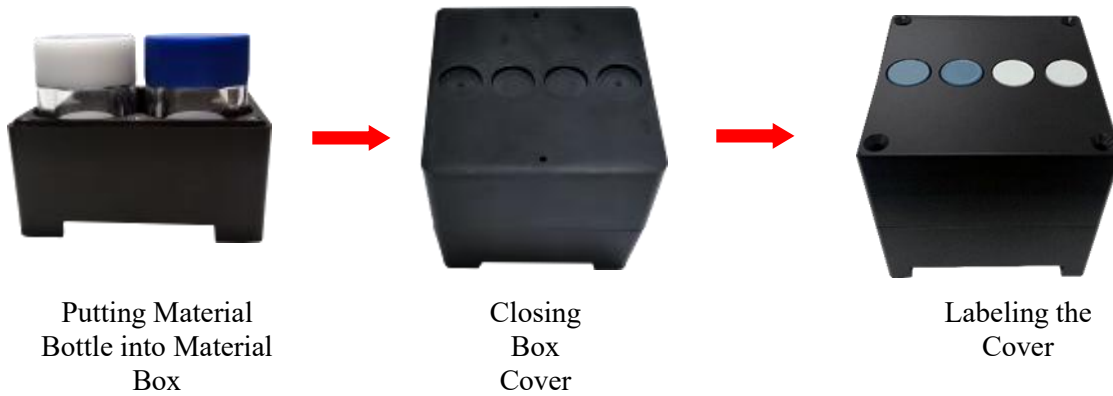

Figure 0-5 Packaging Process

v. Intelligent storage unit: The stacking mechanism takes out the packaging boxes on the material table of the industrial robot handling unit, and then puts them into the corresponding storehouse in sequence according to the requirements. Two 3×3 storehouses are equipped with a detection sensor in each position to detect the empty and full status of the storehouse. The horizontal axis of the stacking mechanism is a precision rotating mechanism, and the vertical mechanism is a turbine screw lifting mechanism, all of which are controlled with high precision by precision servo motors. The travel shaft is driven by a synchronous belt and controlled by a stepper motor.

Task A Mechanical installation and debugging of units

Task scenario:

The installation and wiring of the unit control panel has been completed. Competitors need to use the components and materials purchased by customers. Teams are responsible for completing the assembly of the countertop model mechanism of the particle feeding unit and the detection and sorting unit, and installing the mechanism module and connecting the air pipe on the profile countertop of the station to ensure that the model mechanism can operate correctly and the system complies with professional technical specifications. Besides, teams also need to complete the assembly and debugging of the designated unit within the specified time, so that the production process can be automated in the later stage of the production line. After competitors complete or submit the papers, no modification should be made. Any hardware problems in the marking phase can be solved in the subsequent tasks.

Points	Competition duration	Information
15/100	Task A\B\C (3 hours)	See D drive for details

Task I: Mechanical assembly and debugging of particle feeding unit

1. Task overview

Using the components and materials purchased by the customer, teams are responsible for completing the assembly of the countertop model mechanism, and installing the mechanism module and connecting the air pipe on the profile countertop of the station to ensure correct operation, so that the production process can be automated in the later stage of the production line and the system can comply with professional technical specifications.

Equipment status:

The procurement of components and raw

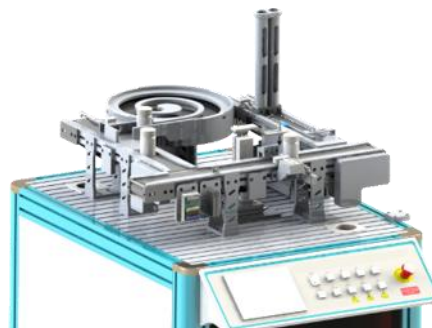

Particle feeding unit

materials and the electrical installation and wiring of the hanging panel have been completed in the unit, but the assembly and mechanism installation of the countertop module have not been carried out.

2. Task description

Complete the mechanical installation and pneumatic connection of the disc feeding mechanism module, the feeding conveyor belt mechanism module, the main conveyor belt module, the particle feeding mechanism module, and the particle filling mechanism module on the countertop of the particle feeding unit.

(1) The initial position of each unit

Feeding conveyor belt module	Main conveyor module	Particle feeding module	Particle filling module	Disc feeding mechanism
① The feeding conveyor belt stops	① The main conveyor belt stops	① The particle feeding conveyor belt stops	① The lifting cylinder rises	① Stop rotating
② Working air pressure 0.4 Mpa - 0.5 Mpa	② Filling and positioning cylinder retracts	② Pushing Cylinder A retracts	② Rotating Cylinder rotates to the right	
		③ Pushing Cylinder B retracts	③ Suction cup is closed	

(2) Mechanical section - general layout

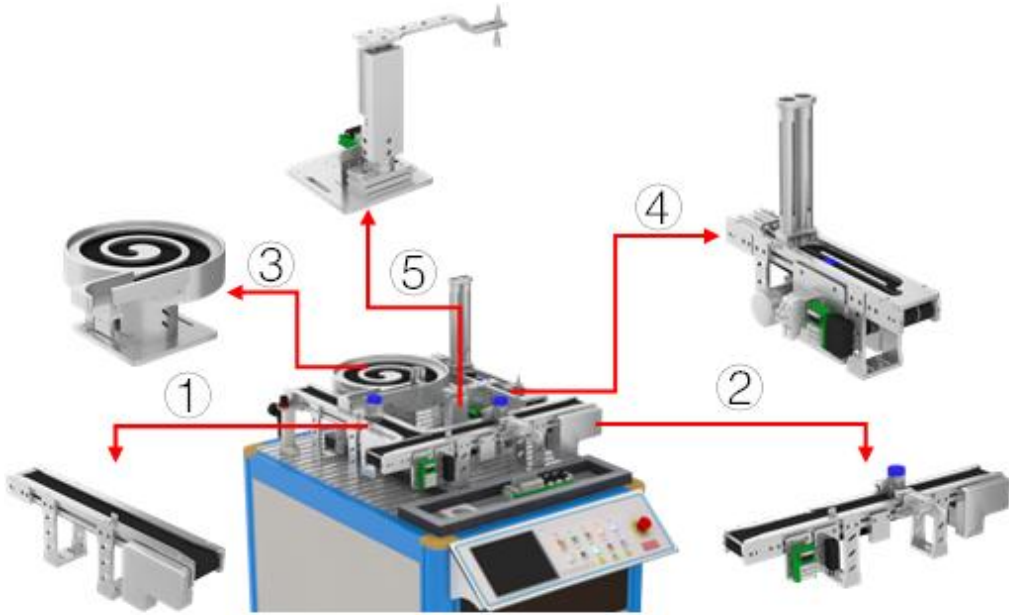

Figure A-01 Mechanical Structure Layout of Particle Feeding Unit

- ①The feeding conveyor belt mechanism module;
 - ②The main conveyor belt mechanism module;
 - ③The particle feeding mechanism module;
 - ④The disc feeding mechanism module;
 - ⑤The particle filling mechanism module;
- (3) Mechanical section - dimension and installation drawings

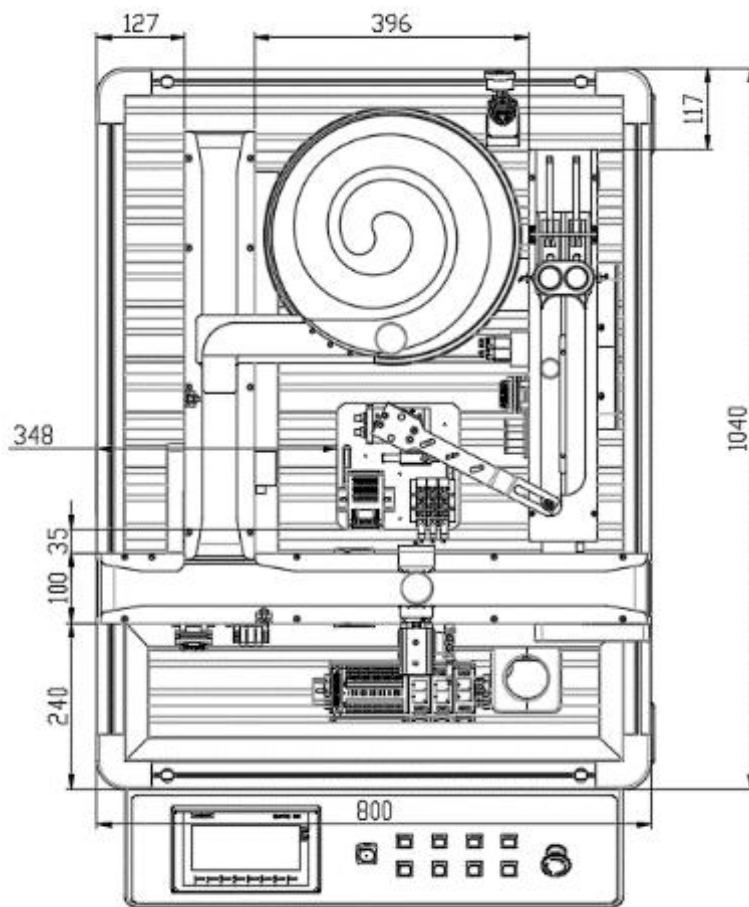

Figure A-02 Mechanical Installation Reference Diagram of Particle Feeding Unit

- (4) Mechanical section - installation tasks

Please complete the component installation and pneumatic connection of the disc feeding mechanism, feeding conveyor belt, main conveyor belt mechanism, particle filling mechanism, and particle feeding mechanism of the particle feeding unit according to the following drawings, and install them on the workbench of this unit according to the relative relationship between each mechanism position.

- ① For the assembly drawing of the feeding conveyor belt, see Mechanical Diagram 1-1;

- ② For the assembly drawing of the main conveyor belt mechanism, see Mechanical Diagram 1-2;
- ③ For the assembly drawing of the particle filling mechanism, see Mechanical Diagram 1-3;
- ④ For the assembly drawing of the particle feeding mechanism, see Mechanical Diagram 1-4;
- ⑤ For the assembly drawing of the disc feeding mechanism, see Mechanical Diagram 1-5;
- ⑥ For the pneumatic diagram of the particle feeding unit, see Mechanical Diagram 1-6;
- ⑦ For the general assembly drawing of the particle feeding unit, see Mechanical Diagram 1-7.

According to the relative positions in the figure, complete the positioning of each mechanism on the unit countertop, and complete the installation and adjustment.

Task II: Detect mechanical assembly and debugging of detection and sorting unit

1. Task overview

Using the components and materials purchased by the customer, teams are responsible for completing the assembly of the countertop model mechanism, and installing the mechanism module and connecting the air pipe on the profile countertop of the station to ensure correct operation, so that the production process can be automated in the later stage of the production line and the system can comply with professional technical specifications.

Equipment status:

The procurement of components and raw materials and the electrical installation and wiring of the hanging panel have been completed in the unit, but the assembly and mechanism installation of the countertop module and robot fixture have not been carried out.

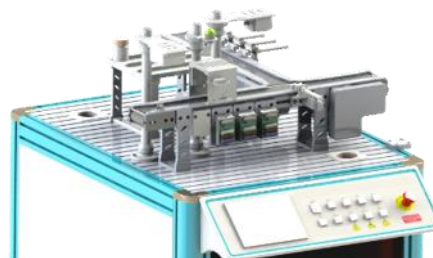

Detection and sorting unit

2. Task description

Complete the mechanical installation and pneumatic connection of the main conveyor belt

mechanism module, sorting conveyor belt mechanism module, sorting mechanism module, RFID mechanism module, vision mechanism module and detection mechanism module on the countertop of the detection and sorting unit.

(1) The initial position of each unit

Sorting mechanism module	Main conveyor belt mechanism module	Sorting conveyor belt mechanism module	Detection mechanism module
① All three cylinders retract	① The main conveyor belt stops	① The sorting conveyor belt stops	① The blue indicator light is on
② Working air pressure 0.4 Mpa - 0.5 Mpa	② Pushing cylinder retracts		

(2) Mechanical section - general layout

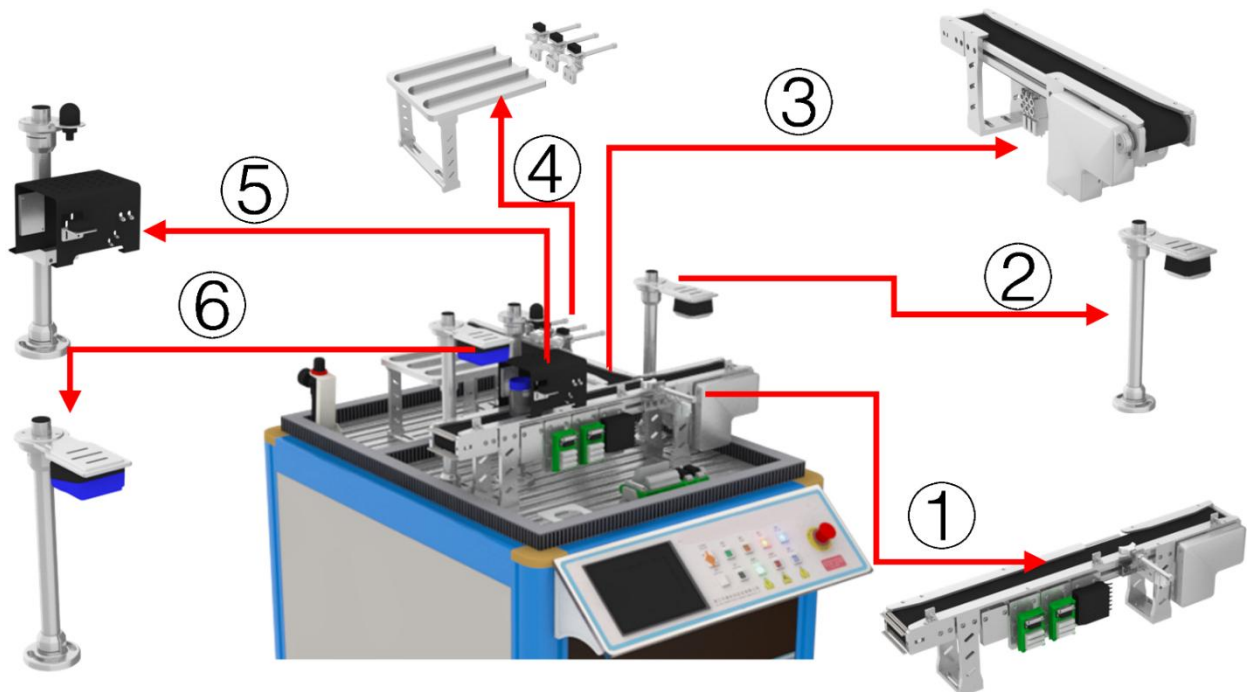

Figure A-03 Mechanical Structure Layout of Detection and Sorting Unit

- ① Main conveyor belt mechanism module;
- ② Machine vision mechanism module;
- ③ Sorting conveyor belt mechanism module;
- ④ Sorting mechanism module;
- ⑤ Detection mechanism module;
- ⑥ RFID detection mechanism module.

(3) Mechanical section - dimension and installation drawings

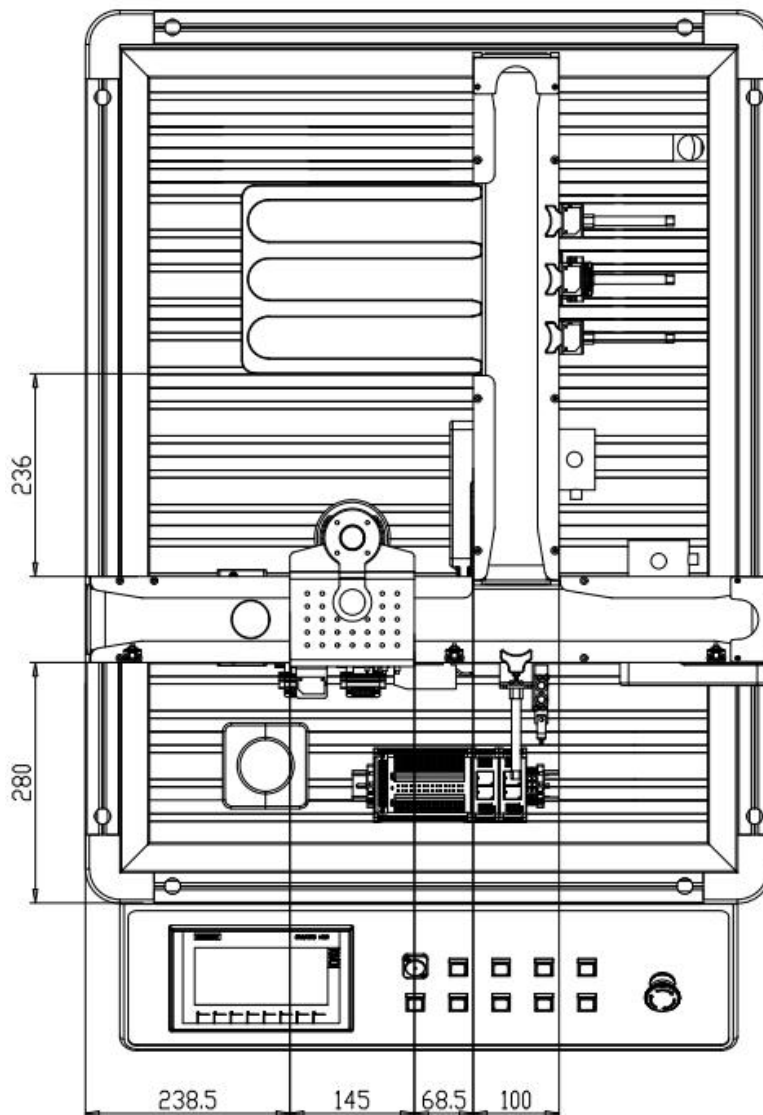

Figure A-04 Reference Diagram for the Mechanical Installation of Detection and Sorting Unit

(4) Mechanical section - installation tasks

Install the main conveyor belt mechanism module, sorting conveyor belt mechanism module, sorting mechanism module, RFID mechanism module, vision mechanism module, and detection mechanism module on the workbench of this unit according to the relative positions of each mechanism, and complete pneumatic connection.

① For the general assembly drawing of the detection and sorting conveyor belt mechanism, see Mechanical Diagram 3-1;

② For the assembly diagram of the main conveyor belt mechanism module of detection and sorting, see Mechanical Diagram 3-2;

③ For the general assembly drawing of the detection mechanism module, see Mechanical Diagram 3-3;

④ For the general assembly drawing of the machine vision mechanism module, see Mechanical Diagram 3-4;

⑤ For the general assembly drawing of the RFID detection mechanism module, see Mechanical Diagram 3-5;

⑥ For the general assembly drawing of the detection and sorting unit, see Mechanical Diagram 3-6. According to the relative positions in the diagram, complete the positioning of each mechanism on the unit countertop, and complete the installation and adjustment.

Task B Electrical installation and debugging of units

Task scenario:

The installation and wiring of the unit control panel has been completed. After competitors complete the mechanical assembly and debugging of Task A, teams are also responsible for completing the wiring and circuit debugging of the countertop model of the particle feeding unit and the detection and sorting unit, to ensure that the circuit can operate correctly and the system meets professional technical specifications. Complete the entire production line within the specified time, so that the production process can be automated in the later stage of the production line. There will be no opportunity for improvement when a competitor finishes the task or hands in the paper.

Points	Competition duration	Information
20/100	Task A\B\C (3 hours)	See D drive for details

Task I: Wiring of particle feeding unit model

Task overview

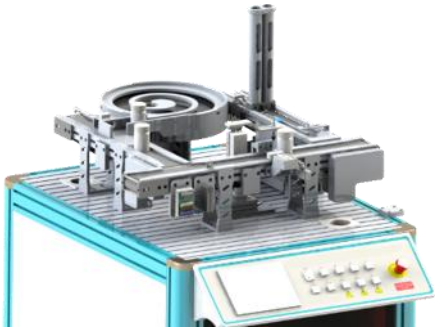
<p>After competitors complete the mechanical installation of the model, teams are also required to complete the wiring and circuit testing of the countertop model which should comply with professional technical specifications, to ensure correct operation, so that the production process can be automated in the later stage of the production line.</p> <p>Equipment status:</p> <p>The wires of the unit model have been machined, but not yet connected to the model.</p>	 <p>Particle feeding unit</p>
---	---

Task description

Complete the terminal board of the CN300 main conveyor belt module, the terminal board of the CN301 particle filling module, the terminal board of CN302 particle feeding module, the 37-pin

terminal board of CN310 desktop, the M1 terminal board of CN320 feeding belt electric motor, the M2 terminal board of CN321 main belt electric motor, the M3 terminal board of CN322 disc electric motor and XT98 terminal wiring on the countertop of the particle feeding unit.

Schematic diagram of desktop terminal board connection

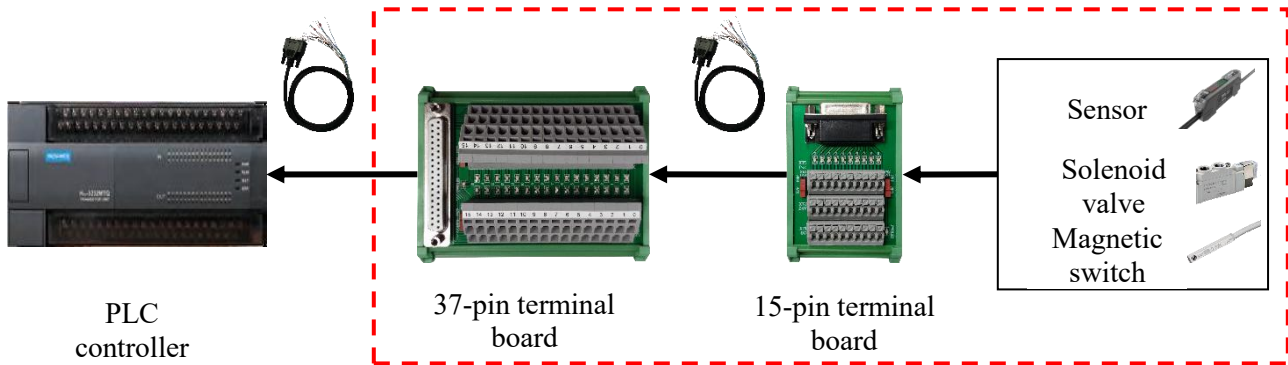
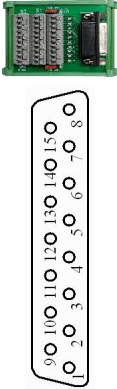
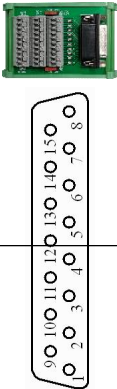

Figure B - 11 Schematic Diagram of Terminal Board Connection

Assignment of the terminal board pin of CN300 main conveyor belt module

	Pin	Wire color	Terminal	Wire No.	Description of function
			XT3-0	X00	Material bottle feeding detection sensor
			XT3-1	X01	Particle filling limit detection sensor
			XT3-2	X07	Rear limit of positioning cylinder
			XT3-3	X25	Disc empty bottle limit sensor
			XT3-5	Y05	Solenoid valve of positioning cylinder
			XT2	PS13+(+24V)	Positive pole of 24 V power supply
			XT1	PS13-(0V)	Negative pole of 24 V power supply

Assignment of the terminal board pin of CN301 particle filling module

	Pin	Wire color	Terminal	Wire No.	Description of function
			XT3-0	X14	Upper limit of filling and lifting cylinder
			XT3-1	X15	Lower limit of filling and lifting cylinder

			XT3-2	X20	Suction cup filling limit
			XT3-3	X23	Left limit of filling rotating cylinder
			XT3-4	X24	Right limit of filling rotating cylinder
			XT3-5	Y02	Solenoid valve of filling rotating cylinder
			XT3-6	Y03	Solenoid valve of filling and lifting cylinder
			XT3-7	Y04	Solenoid valve of reclaiming suction cup
			XT2	PS13+(+24V)	Positive pole of 24 V power supply
			XT1	PS13-(0V)	Negative pole of 24 V power supply

Assignment of the terminal board pin of CN302 particle filling module

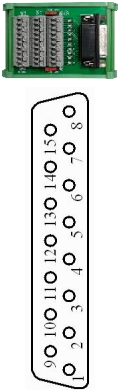
	Pin	Wire color	Terminal	Wire No.	Description of function
			XT3-2	X04	Barrel A material detection sensor
			XT3-3	X05	Barrel B material detection sensor
			XT3-4	X06	Particle limit detection sensor
			XT3-5	X21	Rear limit of Pushing Cylinder A
			XT3-6	X22	Rear limit of Pushing Cylinder B
			XT3-7	Y06	Solenoid valve of Pushing Cylinder A
			XT3-8	Y07	Solenoid valve of Pushing Cylinder B
			XT2	PS13+(+24V)	Positive pole of 24 V power supply
			XT1	PS13-(0V)	Negative pole of 24 V power supply

Assignment of the terminal board pin of CN310 desktop

Pin	Wire color	Terminal	Wire No.	Description of function
		XT3-0	X00	The feeding sensor senses the material, and X0 is closed
		XT3-1	X01	The particle filling position senses the material, and X1 is closed
		XT3-4	X04	It is detected that there is material in Barrel A, and X4 is closed
		XT3-5	X05	It is detected that there is material in Barrel B, and X5 is closed
		XT3-6	X06	It is detected that there is material at the reclaiming position on the conveyor belt, and X6 is closed
		XT3-7	X07	The rear limit of filling and positioning cylinder senses the material, and X7 is closed
		XT3-8	X20	The filling limit of suction cup senses the material, and X20 is closed
		XT3-9	X21	The front limit of Pushing Cylinder A senses the material, and X21 is closed
		XT3-10	X22	The front limit of Pushing Cylinder B senses the material, and X22 is closed
		XT3-11	X23	The left limit of filling rotating cylinder senses the material, and X23 is closed
		XT3-12	X24	The right limit of filling rotating cylinder senses the material, and X24 is closed
		XT3-13	X14	The upper limit of filling and lifting cylinder senses the material, and X14 is closed
		XT3-14	X15	The lower limit of filling and lifting cylinder senses the material, and X15 is

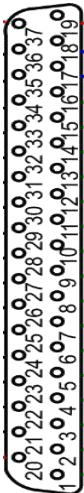

					closed
			XT3-15	X25	Disc empty bottle limit senses the material, and X25 is closed
			XT2-0	Y00	Y0 is closed and the feeding conveyor belt operates
			XT2-1	Y01	Y1 is closed and the main conveyor belt operates
			XT2-2	Y02	Y2 is closed and the filling rotating cylinder rotates
			XT2-3	Y03	Y3 is closed and the filling and lifting cylinder descends
			XT2-4	Y04	Y4 is closed and the suction cup picks up
			XT2-5	Y05	Y5 is closed and the positioning cylinder extends out
			XT2-6	Y06	Y6 is closed and the Pushing Cylinder A pushes the material
			XT2-7	Y07	Y7 is closed and the Pushing Cylinder B pushes the material
			XT2-8	Y30	Y30 is closed, and the disc operates
			XT1\XT4	PS13+(+24V)	Positive pole of 24 V power supply
			XT5	PS13-(0V)	Negative pole of 24 V power supply

Assignment of M1 terminal board pin of CN320 feeding belt electric motor

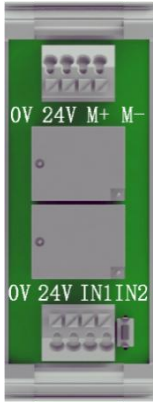
	Pin	Wire color	Terminal	Wire No.	Description of function	
			0V	PS13-		Negative pole of 24 V power supply
			24V	PS13+		Positive pole of 24 V power supply
			M+	M1+		Positive pole of feeding belt electric motor
			M-	M1-		Negative pole of feeding belt electric motor
			IN2	Y0		Y0 is closed and the feeding conveyor belt operates
			0V	PS13-		Negative output of 24 V power supply
			24V	PS13+		Positive output of 24 V power supply

Assignment of M2 terminal board pin of CN321 main belt electric motor

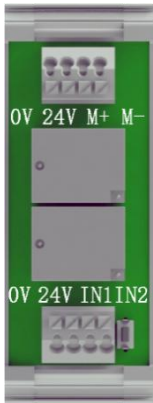
	Pin	Wire color	Terminal	Wire No.	Description of function	
			M+	M2+		Positive pole of main belt electric motor
			M-	M2-		Negative pole of main belt electric motor
			IN2	Y1		Y1 is closed and the main conveyor belt operates
			0V	PS13-		Negative input of 24 V power supply
		24V	PS13+		Positive input of 24 V power supply	

Assignment of M3 terminal board pin of CN321 disc electric motor

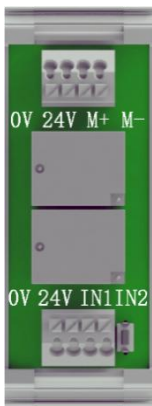
	Pin	Wire color	Terminal	Wire No.	Description of function	
				0V	PS13-	Negative pole of 24 V power supply
				24V	PS13+	Positive pole of 24 V power supply
				M+	M3+	Positive pole of disc electric motor
				M-	M3-	Negative pole of disc electric motor
				IN2	Y30	Disc operates, and Y30 is closed
				0V	PS13-	Negative input of 24 V power supply
				24V	PS13+	Positive input of 24 V power supply

Assignment of XT98 terminal board pin

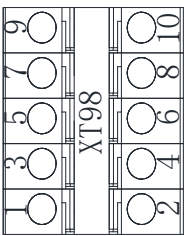
	Pin	Wire color	Terminal	Wire No.	Description of function	
				01	PS13-(0V)	37-pin terminal board: 0 V
				02	PS13-(0V)	XT99 terminal board: 2-16
				03	PS13+(+24V)	37-pin terminal board: 24V
				04	PS13+(+24V)	XT99 terminal board: 1-16
				05	U	U pole of inverter motor
				06	U	U pole of frequency converter
				07	V	V pole of inverter motor
				08	V	V pole of frequency converter
				09	W	W pole of inverter motor
			10	W	W pole of frequency converter	

Task II: Detect the wiring of the sorting unit model

Task overview

After competitors complete the mechanical installation of the model, teams are also required to complete the wiring and circuit testing of the countertop model which should comply with professional technical specifications, to ensure correct operation, so that the production process can be automated in the later stage of the production line.

Equipment status:

The wires of the unit model have been machined, but not yet connected to the model.

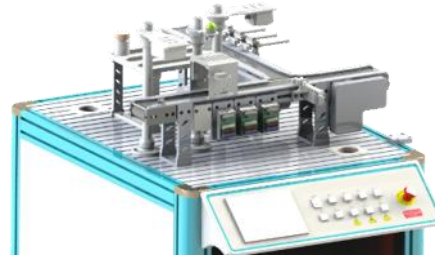

Detection and sorting unit

Task description

Complete the terminal board of CN300 main conveyor belt module, the terminal board of the indicator light sorting module of CN301 detection mechanism, the terminal board of CN302 auxiliary conveyor belt module, the 37-pin terminal board of CN310 desktop, the M1 terminal board of CN320 tape conveying motor, M2 terminal board of the CN321 auxiliary conveyor belt and XT98 terminal wiring on the countertop of the detection and sorting unit.

Schematic diagram of desktop terminal board connection

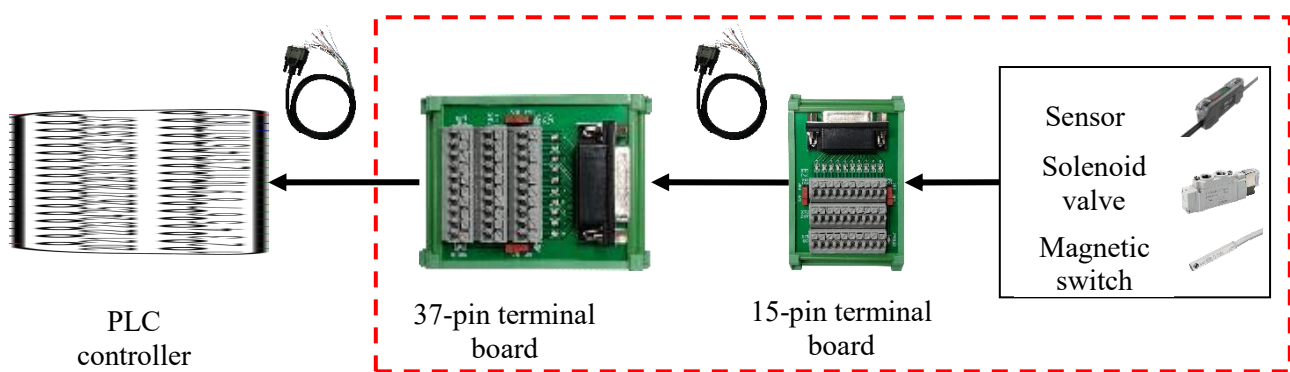





Figure B-2 Schematic Diagram of Terminal Board Connection

Assignment of the terminal board pin of CN300 main conveyor belt module

 	Pin	Wire color	Terminal	Wire No.	Description of function
			XT3-0	X00	Feeding detection sensor
			XT3-1	X01	Tightening detection sensor
	Pin	Wire color	Terminal	Wire No.	Description of function
			XT3-2	X03	Bottle cap blue detection sensor
			XT3-3	X04	Bottle cap white detection sensor
			XT3-4	X05	Unqualified limit detection sensor
			XT3-5	X06	Discharge detection sensor
			XT3-6	X07	Rear limit of sorting cylinder
			XT3-7	X14	Three material limit detection
			XT3-8	X15	Four material limit detection
			XT2	PS13+ (+24V)	Positive pole of 24 V power supply
			XT1	PS13-(0V)	Negative pole of 24 V power supply

Assignment of the terminal board pin of the indicator light sorting module of CN301 detection mechanism

 	Pin	Wire color	Terminal	Wire No.	Description of function
			XT3-0	Y02	The indicator light of the detection mechanism is always on in green
			XT3-1	Y03	The indicator light of the detection mechanism is always on in red
			XT3-2	Y04	The indicator light of the detection mechanism is always on in blue
			XT3-3	Y05	Solenoid valve of sorting cylinder
			XT3-4	Y06	The indicator light of the detection mechanism is always on in yellow
			XT2	PS13+ (+24V)	Positive pole of 24 V power supply
		XT1	PS13-(0V)	Negative pole of 24 V power supply	

Assignment of the terminal board pin of CN302 auxiliary conveyor belt module

Pin	Wire color	Terminal	Wire No.	Description of function
		XT3-0	X20	Unqualified bottle cap sorting detection sensor
		XT3-1	X21	Rear limit of the unqualified bottle cap sorting cylinder
		XT3-2	X22	Unqualified material sorting detection sensor
		XT3-3	X23	Rear limit of unqualified material sorting cylinder
		XT3-4	X24	Unqualified bottle cap and material sorting detection sensor
		XT3-5	X25	Rear limit of unqualified bottle cap and material sorting cylinder
		XT3-6	Y20	Solenoid valve of unqualified bottle cap sorting cylinder
Pin	Wire color	Terminal	Wire No.	Description of function
		XT3-7	Y21	Solenoid valve of unqualified material sorting cylinder
		XT3-8	Y22	Solenoid valve of unqualified bottle cap and material sorting cylinder
		XT2	PS13+(+24 V)	Positive pole of 24 V power supply
		XT1	PS13-(0V)	Negative pole of 24 V power supply



Assignment of the terminal board pin of CN310 desktop

Pin	Wire color	Terminal	Wire No.	Description of function
		XT3-0	X00	Feeding detection sensor
		XT3-1	X01	Bottle cap tightening detection sensor
		XT3-3	X03	Bottle cap blue detection sensor
		XT3-4	X04	Bottle cap white detection sensor
		XT3-5	X05	Unqualified limit detection sensor
		XT3-6	X06	Discharge detection sensor
		XT3-7	X07	Rear limit of sorting cylinder

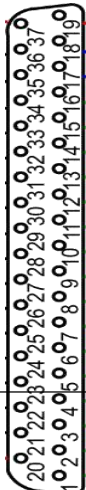
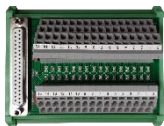

		XT3-8	X20	Unqualified bottle cap sorting detection sensor
		XT3-9	X21	Rear limit of the unqualified bottle cap sorting cylinder
		XT3-10	X22	Unqualified material sorting detection sensor
		XT3-11	X23	Rear limit of unqualified material cylinder
		XT3-12	X14	Three material limit detection
		XT3-13	X15	Four material limit detection
		XT3-14	X24	Unqualified bottle cap and material sorting detection sensor
		XT3-15	X25	Retract limit of unqualified bottle cap and material sorting cylinder
		XT2-0	Y00	Main conveyor belt operates
		XT2-1	Y01	Auxiliary conveyor belt operates
		XT2-2	Y02	The tower detection indicator light is always on in green
		XT2-3	Y03	The tower detection indicator light is always on in red
		XT2-4	Y04	The tower detection indicator light is always on in blue
		XT2-5	Y05	Solenoid valve of sorting cylinder
		XT2-6	Y06	The tower detection indicator light is always on in yellow
		XT2-8	Y20	Solenoid valve of unqualified bottle cap detection cylinder
		XT2-9	Y21	Solenoid valve of unqualified material detection cylinder
		XT2-10	Y22	Solenoid valve of unqualified bottle cap and material detection cylinder
		XT1\XT4	PS13+(+24 V)	Positive pole of 24 V power supply
		XT5	PS13-(0V)	Negative pole of 24 V power supply
Pin	Wire color	Terminal	Wire No.	Description of function

Assignment of M2 terminal board pin of CN320 main tape conveying motor

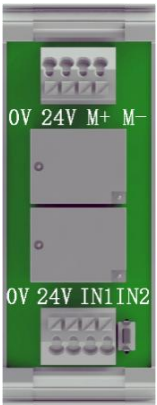
	Pin	Wire color	Terminal	Wire No.	Description of function	
				0V	PS13-	Negative pole of 24 V power supply
				24V	PS13+	Positive pole of 24 V power supply
				M+	M+	Positive pole of main tape conveying motor
				M-	M-	Negative pole of main tape conveying motor
				IN2	Y0	Y0 is closed and main conveyor belt operates
				0V	0V	Negative output of 24 V power supply
				24V	24V	Positive output of 24 V power supply

Assignment of M2 terminal board pin of CN320 auxiliary tape conveying motor

	Pin	Wire color	Terminal	Wire No.	Description of function	
				0V		
				24V		
				M+	M+	Positive pole of auxiliary tape conveying motor
				M-	M-	Negative pole of auxiliary tape conveying motor
				IN2	Y1	Y1 is closed and the auxiliary conveyor operates
				0V	0V	Negative input of 24 V power supply
				24V	24V	Positive input of 24 V power supply

Assignment of XT98 terminal board pin

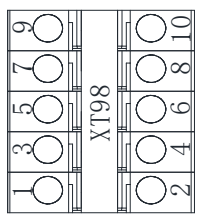
	Pin	Wire color	Terminal	Wire No.	Description of function	
				01	PS13+(+24V)	CN320 terminal board: 24V
				02	PS13+(+24V)	XT99 terminal board: 16.1
				03	PS13-(0V)	CN320 terminal board: 0 V
				04	PS13-(0V)	XT99 terminal board: 16.2

Task C Troubleshooting of units

Task scenario:

Since the capping and screw capping unit and the intelligent storage unit have just been installed and wired, there is a fault. Teams are now required to complete the identification and elimination of the equipment fault, and fill in the **Troubleshooting Answer Sheet**, and the results will be evaluated accordingly. Fault points that cannot be eliminated will not be given marks. If the number of rows in the Troubleshooting Answer Sheet is insufficient, teams can fill in additional rows on their own.

Points	Competition duration	Information
9/100	Task A\B\C (3 hours)	See D drive for details

Task overview

During the installation and wiring process, there may be conditions such as poor contact of lines or device connectors, unstable signal transmission, unreasonable use of device settings, and excessive mechanical assembly errors, resulting in fault of unit operation. Teams are now required to complete the troubleshooting of the capping and screw capping unit and the intelligent storage unit, so that the production process can be automated in the later stage of the production line.

Equipment status:

The unit has been installed and wired. Since the hardware fault of the unit will affect the automatic operation of the program and easily cause safety accidents, the fault maintenance of the unit has not been carried out.



Capping and screw capping

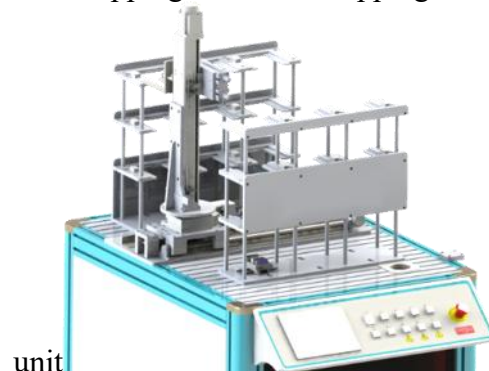

Intelligent storage unit

Task description

The task of teams is to operate and debug the two units and eliminate faults such as those in electrical circuits and components, according to the control function requirements of the capping and

screw capping unit and the intelligent storage unit, the mechanical structure drawings, and the installation requirements for the I/O allocation table specified in the electrical wiring drawings, so as to ensure that the circuits, pneumatic and mechanical mechanisms in the two units can operate normally. Fill in the **Troubleshooting Answer Sheet** with the description of the fault, the analysis of the faulty parts, and the troubleshooting steps.

The relevant drawings of the equipment are as follows:

For the electrical schematic diagram of the equipment, please refer to the attached drawing - Capping and screw capping unit - Intelligent storage unit.